

## Swivel mounting bracket to adjust the angle of the display unit

The gimbal mount allows the display unit to swivel around when desktop mounted. You can adjust the angle of the display so that the optimum viewing angle can be easily achieved.



## SPECIFICATIONS OF FCV-587

|                             |                                                                                                                                                                                                                         |
|-----------------------------|-------------------------------------------------------------------------------------------------------------------------------------------------------------------------------------------------------------------------|
| <b>GENERAL</b>              |                                                                                                                                                                                                                         |
| Frequency                   | 50 and 200 kHz                                                                                                                                                                                                          |
| Output Power                | 600 W/1 kW*<br>*Matching Box MB-1100 required                                                                                                                                                                           |
| <b>DISPLAY</b>              |                                                                                                                                                                                                                         |
| Display Type                | 8.4" color LCD                                                                                                                                                                                                          |
| Effective Display Area      | 128.2 (W) x 170.9 (H) mm                                                                                                                                                                                                |
| Pixel Number                | 640 x 480 (VGA)                                                                                                                                                                                                         |
| Display                     | Single frequency (50 or 200 kHz), Dual-frequency, Zoom, Nav data, A-scope, Marker zoom, Bottom zoom, Bottom-lock, Bottom Discrimination, ACCU-FISH™                                                                     |
| Basic Range                 | 2-1200 m*<br>*m, ft, fm, HR, pb can be selected in the menu                                                                                                                                                             |
| Alarm                       | Bottom, Fish (Normal), ACCU-FISH™, Fish (B/L), Bottom Discrimination, Fish Level, Temperature, Speed, Arrival and Battery                                                                                               |
| Language                    | English, French, Spanish, German, Italian, Portuguese, Greek, Polish, Danish, Swedish, Norwegian, Finnish, Chinese, Japanese, Thai, Vietnamese up to 1200 m                                                             |
| Range Phasing               | up to 1200 m                                                                                                                                                                                                            |
| Expansion Range             | Bottom-lock expansion: 2-10 m<br>Sectional expansion: 2-1200 m                                                                                                                                                          |
| Picture Advance Speed       | 8 steps: stop, 1/16, 1/8, 1/4, 1/2, 1, 2, 4                                                                                                                                                                             |
| Pulselength & PRR Interface | 0.1-3 ms, Max 3,000 pulse/min<br>(Input) BWC, GGA, GLL, GNS, HDG, HDT, MDA, MTW, MWV, RMA, RMB, RMC, VHW, VTG, XTE, ZDA<br>(Output) DBS, DBT, DPT, MTW*, RMB*, VHW*, TLL* by key operation<br>* External data required. |

|                     |                   |
|---------------------|-------------------|
| <b>ENVIRONMENT</b>  |                   |
| Temperature         | -15°C to +55°C    |
| Waterproofing       | IP56              |
| <b>POWER SUPPLY</b> | 12-24 VDC, 15.7 W |

- EQUIPMENT LIST**
- Standard**
1. Display Unit CV-587
  2. Installation Materials and Standard Spare Parts
- Option**
1. Speed/Temperature Sensor  
ST-02MSB (Bronze, thru-hull), ST-02PSB (Plastic, thru-hull), T-02MTB (Bronze, transom), T-02MSB (Bronze, thru-hull), T-03MSB (Bronze, thru-hull)
  2. Connector Kit for Connection of Temperature Sensor or Speed & Temperature Sensor
  3. Matching Box MB-1100 (For 1 kW output with some transducers)
  4. NMEA+Power Cable

**Transducers (Specify when ordering)**

**600 W**  
520-5PSD (Plastic, thru-hull), 520-5MSD (Bronze, thru-hull), 525-5PWD (Plastic, transom), 525STID-MSD (Bronze, thru-hull, with a speed/temp sensor), 525STID-PWD (Plastic, transom, with a speed/temp sensor)

**1 kW**  
50 kHz: 50B-6, 50B-6B  
200 kHz: 200B-5S  
50/200 kHz dual-frequency: 50/200-1T

### DISPLAY UNIT

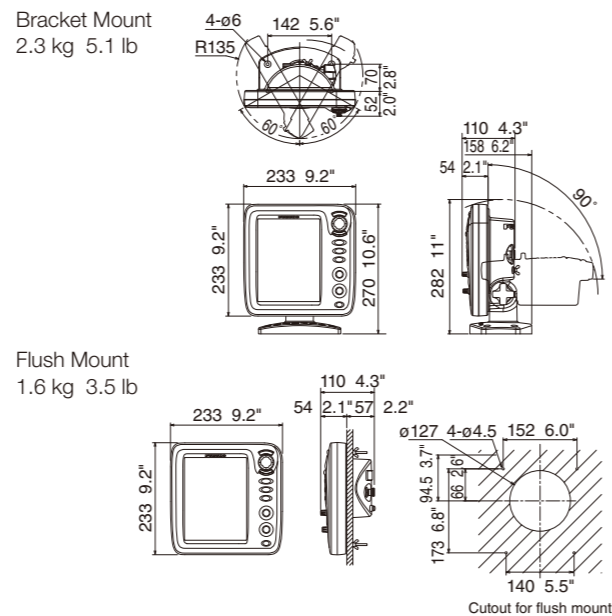

### INTERCONNECTION DIAGRAM

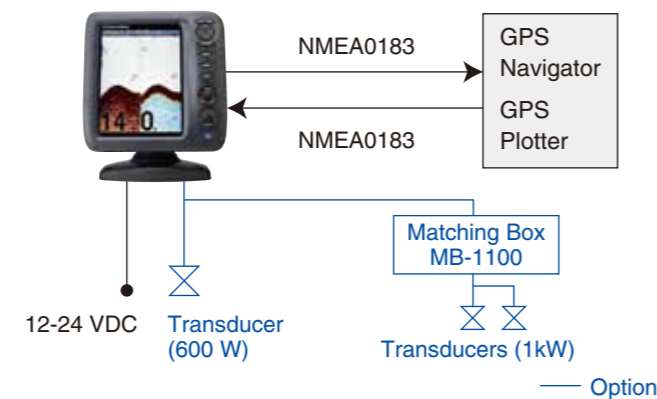

All brand and product names are registered trademarks, trademarks or service marks of their respective holders.  
SPECIFICATIONS SUBJECT TO CHANGE WITHOUT NOTICE

## 8.4" Color LCD FISH FINDER

Model **FCV-587**

The **FCV-587** now has the ability to acquire **fish size** and **bottom structure** under your boat!







# The FCV-587 now has the ability to acquire **fish size** and **bottom structure** under your boat!



8.4" Color LCD FISH FINDER  
Model FCV-587



- ▶ **Equipped with Furuno's latest technology: the Bottom Discrimination Function - Analyze bottom structure\***
  - Provides an at-a-glance recognition of bottom form with four types of graphical displays (Rocks/Sand/Gravel/Mud) when connected to required thru-hull or transom mount transducer.
  - \* Thru-hull or transom transducer mount required
- ▶ **ACCU-FISH™ - A unique fish size analyzer based on the latest digital technology**
- ▶ **White Line feature - Discriminate fish lying near the bottom**
  - The top edge of the sea floor is displayed in white to clearly show bottom structures.
  - This feature helps to discriminate weeds and bottom fish distinctly.
- ▶ **Configurable Alarm function (depth, fish echoes, etc.)**
- ▶ **Post-processing Gain Control applied to all echoes displayed on the screen**
- ▶ **Share and display information on a chartplotter\***
  - Furuno's TLL (Target Lat/Lon) output allows you to interface the FCV-587 with your chartplotter so that you can mark fishing spots with various information (L/L, Depth, Water Temp, Fish size, Bottom).
  - \* Required connection to chart plotter.
- ▶ **Fast transmission rate of 3,000 PRR (Pulse Repetition Rate) per minute (at 5 m depth range)**
- ▶ **Bright 800 cd/m<sup>2</sup> LCD gives excellent readability, even in bright sunlight**
  - The LCD and the AR glass are bonded together to ensure no fogging issues.
  - Clear visibility even when wearing polarized sunglasses.

|                                                                                                                       |                                                                                                                        |
|-----------------------------------------------------------------------------------------------------------------------|------------------------------------------------------------------------------------------------------------------------|
| <br>Auto Tuning<br>(Sensitivity) | <br>Enhanced<br>Sunlight Viewable |
| <br>Bonded LCD                   | <br>Polarized<br>Friendly         |
| <br>FURUNO Digital<br>Filter     | <br>Bottom<br>Discrimination      |
| <br>ACCU-FISH                    |                                                                                                                        |

# DIGITAL FISH FINDER

# “ACCU-FISH™” identifies individual fish with size and fish mark function

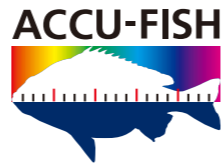

## Recognizes individual or multiple fish instantaneously

ACCU-FISH™ is a revolutionary fish size assessment function of the FCV-587. In order to assess individual fish size, the echo strength from the fish needs to be computed and turned into fish size display on the screen. It can detect the fish size of 10 to 199 cm, in the depth of 2 to 100 m.

## Displaying fish marks

The fish mark can be utilized to display on individual fish echoes when detected. It helps beginners to identify the fish targets on the display for a more fun fishing experience.

Fish mark is selectable from two types of fish symbol, circle and square. The fish symbol, displayed in two different sizes (Large: over 50 cm, Small: 10 to 49 cm), is a great help for anglers to identify fish targets. Circle and square identify targets without hiding fish echo.

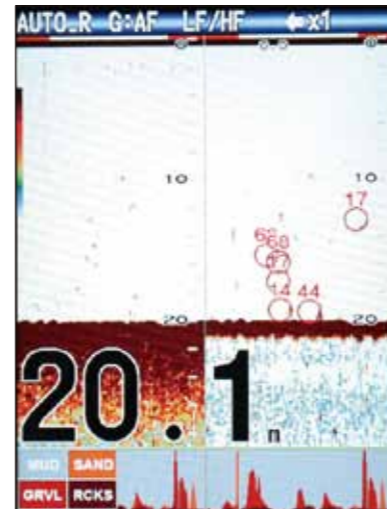
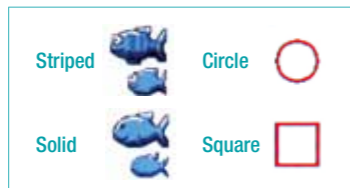

Circles and fish size are displayed on fish echoes. When in dual frequencies mode, you can set the mark displayed on both or either frequency screen.

## Displaying fish size or fish depth

Activating the ACCU-FISH™ from the menu, FCV-587 displays fish size on the individual fish echo. When the ACCU-FISH™ is used concurrently with fish marks, it greatly helps anglers to identify fish targets on the display. You may also select and display the target depth instead of fish size, which helps to see how far the fish is from the boat.

*In some instances, fish size indicated on the FCV-587 may differ from its actual size. Please read the operation manual carefully before using this feature.*

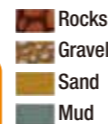
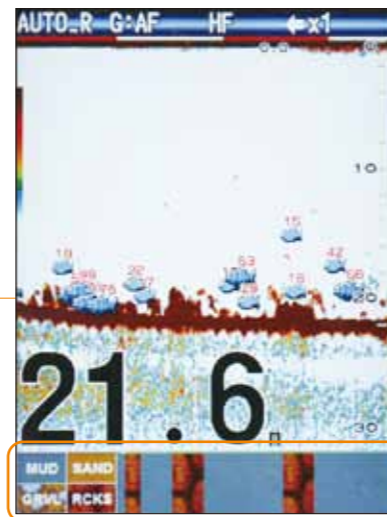

# Bottom Discrimination feature

The FCV-587's Bottom Discrimination feature enables the fish finder to indicate if the major component of the bottom is rocks, gravel, sand, mud. The Bottom Discrimination Function provides you with valuable information to locate rich fishing grounds, while boosting your catch of the day.

Please keep the following in mind when using the Bottom Discrimination Sounder:

- 1) Use at a depth of 5 m - 100 m.
- 2) Use transducer in transom mount or thru-hull mount.
- 3) To show a consistent display of the actual bottom, set the range display of the fish finder screen to "auto".
- 4) Enter the ship's draft value.
- 5) Use a ship speed of 10 kn or less.
- 6) In some instances, bottom component indicated on the FCV-587 may differ from its actual bottom structure.



### Graphic mode

The standard graphic display mode shows the most probable bottom composition by graphic or four colors.

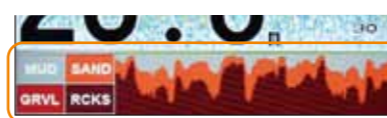

### Probability mode

The probability display mode shows the most probable bottom composition in graph form.

# White Line function distinguishes fish from bottom

The white line function helps you distinguish bottom fish from the bottom by changing the strongest signal color to white. This function is not only useful discriminating bottom fish but is also valuable for judging fish school density. The setting range is 0%-100%, in intervals of 1%. The higher the value the thicker the line.

## Field Test

Screen shot from fish reef in lake: Many fish marks appear on the screen in the thick weed bed. The white line function helps distinguish bottom and weed from the actual fish.



# Post-Processing Gain Control

With conventional gain controls, changes are made for new echoes only when a change in the gain setting is applied. With the FCV-587's Post-Processing Gain Control, changes in the gain setting are applied to new echoes as well as all of the echoes already on the screen. Because the changes are applied to both new and existing returns, you will be able to quickly and easily find the right gain setting for your conditions.

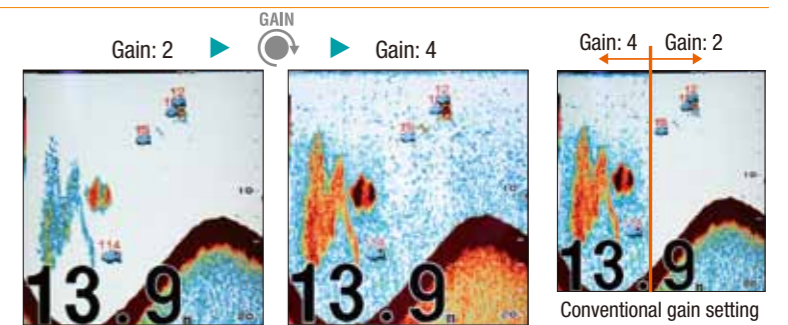

# Bright LCD for excellent in sunlight viewability

Bright 800 cd/m<sup>2</sup> LCD gives excellent readability even in bright sunlight.

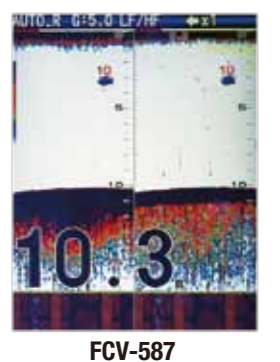
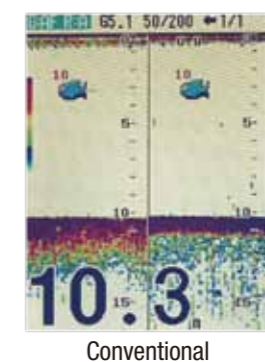

# Fish Alarm function

When fish echoes come in the area which you set above the bottom, beeps sound and the alarm icon flashes at the top right corner of the screen. Furthermore, an integrated alarm setting is also available that can be set by every and each condition, including water depth, target depth, water temp, bottom component, etc.

