

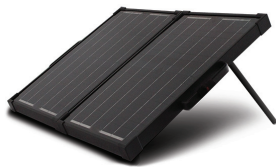

Solar Briefcase Kit

User Manual

40W



55701

80W



55704

120W



55702



WARNING: Read carefully and understand all ASSEMBLY AND OPERATION INSTRUCTIONS before operating. Failure to follow the safety rules and other basic safety precautions may result in serious personal injury.

SAVE THESE INSTRUCTIONS

Important Safety Information

Thank you for choosing a Nature Power Product.

Save the receipt and these instructions. It is important that you read the entire manual to become familiar with this product before you begin using it.

This product is designed for certain applications only. The distributor cannot be responsible for issues arising from modification. We strongly recommend this product not be modified and/or used for any application other than that for which it was designed. If you have any question relative to a particular application, Do not use the product until you have first contacted the distributor to determine if it can or should be performed on the product.

For technical question please call 1800-588-0590

WARNING

- Read and understand all instructions. Failure to follow all instructions may result in serious injury or property damage.
- The warnings, cautions, and instructions in this manual cannot cover all possible conditions or situations that could occur. Exercise common sense and caution when using this tool. Always be aware of the environment and ensure that the tool is used in a safe and responsible manner.
- Do not allow persons to operate or assemble the product until they have read this manual and have developed a thorough understanding of how it works.
- Do not modify this product in any way. Unauthorized modification may impair the function and/or safety and could affect the life of the product. There are specific applications for which the product was designed.
- Use the right tool for the job. DO NOT attempt to force small equipment to do the work of larger industrial equipment. There are certain applications for which this equipment was designed. It will be a safer experience and do the job better at the capacity for which it was intended. DO NOT use this equipment for a purpose for which it was not intended.
- Industrial or commercial applications must follow OSHA requirements.



WARNING

This product can expose you to chemicals, including Di (2-ethylhexyl) phthalate (DEHP) which is known to the State of California to cause cancer, birth defects or other reproductive harm. For more information, go to www.p65warnings.ca.gov



ADVERTENCIA

Este producto puede exponerlo a productos químicos, incluidos Di (2-etilhexil) ftalato (DEHP) que el estado de California sabe que causa cáncer, defectos de nacimiento u otros daños reproductivos. Para obtener más información, vaya a www.p65warnings.ca.gov

Parts List

55701

Reference	Part Description	Quantity
1	2x20 Watt folding solar panel briefcase	1
2	Battery clamps	1
3	Mounting poles	2
4	Bare wire	1
5	Polarity adapter	1
6	Charge controller (attached to panel)	1

55704

Reference	Part Description	Quantity
1	2x40 Watt folding solar panel briefcase	1
2	Battery clamps	1
3	Bare wire	1
4	Polarity adapter	1
5	Charge controller (attached to panel)	1

55702

Reference	Part Description	Quantity
1	2x60 Watt folding solar panel briefcase	1
2	Battery clamps	1
3	Bare wire	1
4	Polarity adapter	1
5	Charge controller (attached to panel)	1

Use and care

Do not modify the Solar Panel in any way. Unauthorized modification may impair the function and/or safety and could affect the life of the equipment. There are specific applications for which the Solar Panel designed.

Always check of damaged or worn out parts before using the Solar Panel. Broken parts will affect the Panel operation. Replace or repair da1naged or worn parts hn1nediately.

Store idle Solar Panel. When Solar panel is not in use, store it in a secure place out of the reach of children. Inspect it for good working condition prior to storage and before re-use.

Solar Panel is water resistant, yet the quick connect wiring and adapter plugs 1nust be kept dry.

Solar Panel will not charge non-rechargeable batteries. This product is designed to charge standard 12V batteries and laptops. product is to be used on 12V configurations in parallel only. Positive(+) to Positive (+), Negative (-) to Negative (-).

Operation

CONNECTING TO A RECHARGEABLE 12V BATTERY:

1. Connect the quick connect cable to the lead coming from the Solar Panel and then into Solar Panel port of Charge Controller.
2. Attach the quick connect end of battery clamps into Output port of Charge Controller.
3. Connect the Red -Positive (+) clamp/wire to the Positive (+) battery terminal.
4. Connect the Black -Negative(-) clamp/wire to the negative(-) battery terminal.
5. Confirm that both connections are tight and secure.

WARNING: Ensure that the positive matches the positive and the negative matches the negative. (Connections are in Parallel) Wrong connection may cause sparks and void the warranty.

TESTING

You may use a voltage meter or a digital multi-meter to measure the voltage of your solar panel before connecting to the battery. Voltage can range between 15-22 volts. Testing will ensure correct charging operation. (Testing equipment not included)

LOCATION OF SOLAR PANEL

For best results, please locate your Solar Panel in a position where it can absorb direct sunlight and generally free from cover and shade.

MAINTENANCE

Maintain your Solar Panel. It is recommended that the general condition of any Solar Panel be examined before it is used. Clean the solar module with a damp towel to insure optimum performance of the Solar Panel. Do not use any type of solvent for cleaning and be careful not to put too much pressure on the module while cleaning

Specification

	55701	55704	55702
Maximum Power(Pmax)	40W	80W	120W
Open-circuit voltage (Voc)	21.2V	22.2V	21.2V
Short-circuit voltage(Isc)	2.44A	4.61A	7.33A
Voltage at Pmax(Vmp)	18.0V	18.0V	18.0V
Current at Pmax(Imp)	2.22A	4.28A	6.67A
Power tolerance	±3%	±3%	±3%
Maximum system voltage	600V	600V	600V
Dimensions(closed)	15.6*16.7*2.32 in	20.7*21.6*2.6 in	21.0*32.8*3.07 in
Certify	ROHS CE		
Test standard	Test condition:AM=1.5; E=1000W/m2; Tc=25		

Reverse Polarity Adapter

Use with the Zamp Solar connector on RV's

Your solar panel output terminals, either directly from the solar panel, or via the Charge Controller, are always Female Positive Polarity:

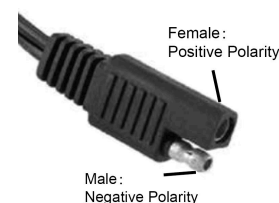

In case you need to have a Female Negative Polarity output, you may use the Reverse Polarity Adapter provided:



CAUTION: Reversing the polarity may damage the electrical appliances! Please check carefully the correct polarity before using.

Intelligent Solar Charge Controller



WARNING: CHARGE CONTROLLER ONLY WORKS WHEN A 12V BATTERY IS PROPERLY CONNECTED. Product Introduction

This intelligent, multi-purpose solar charge and discharge controller has a friendly interface, featuring an LCD display. Various control parameters can be adjusted to meet various application requirements. It has the following features:

Features

- Graphic symbols
- Adjustable operating mode of load
- Battery low voltage disconnection (LVD)
- Over current protection
- Automatic Identification of System Voltage Level
- Simple button operation
- Intelligent PWM charging mode
- Adjustable charge-discharge controller parameters
- Battery reverse-discharge protection
- Battery reverse connection protection
- USB output charger

Cautions

Have all required tools ready and nearby. Ensure properly sized copper wiring is used, improper sized wiring can cause power loss due to heat, or failure of the device. The wire size required will be determined by the distance of the wire run between the solar panel and the batteries. The 40 Watt Briefcase Solar Panel has a maximum output of 2.22A, and the 120 Watt Briefcase Solar Panel has a maximum output of 6.67 A. Please consult a DC voltage wire size guide to determine the appropriate size wire for your installation. A void installing or placing the solar panel and charge controller in areas with flammable, explosive or corrosive gases. Allow for good ventilation and heat dissipation by keeping a clear area of 12 inches around the solar panel and charge controller.

Open the Briefcase Solar Panel and place in an area where it will receive maximum sunlight.

Cover the solar panel with an opaque fabric to obscure from sunlight while making connections.

Use included battery clamps to connect the charge controller to the battery. Maintain proper polarity, positive (+, red) to positive (+, red), and negative (-, black) to negative (-, black). The battery indicator light on the controller will light up to indicate a successful connection.

If desired, connect a DC load using the supplied cable. Ensure a battery is always connected when using the load port.

To disconnect, first disconnect the solar panel from the charge controller, only once solar panel is disconnected, is it safe to disconnect the battery and load.

Take caution to ensure polarity is maintained, reverse polarity can damage the battery and any load connected.

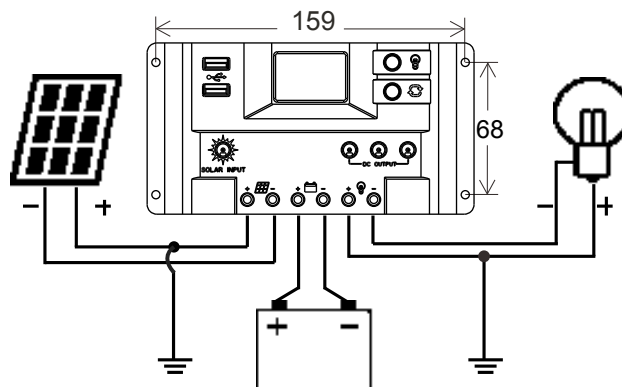

Fast Connect

This solar charge controller equip with fast connector for the solar input port and DC output port, the socket plug are required.

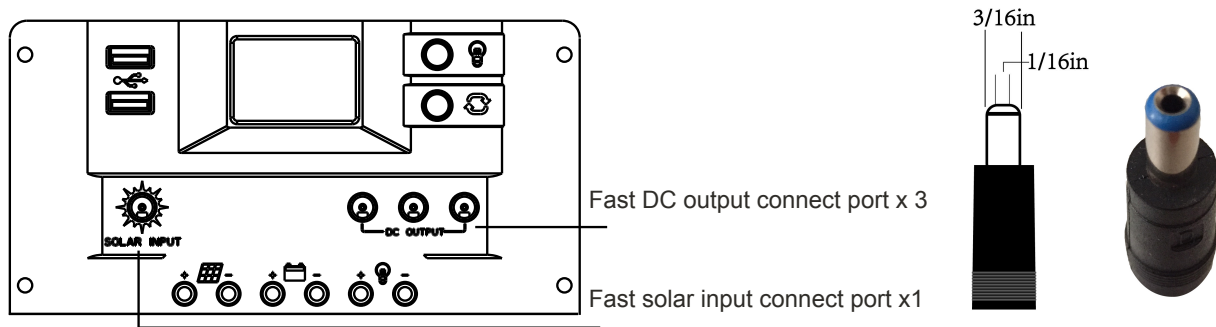

Operation

Operation

Description of LCD graphic symbol

P1: Digital parameters

P2: Charging indication. This symbol indicates that the solar panel is charging the battery: if this symbol is not present, it means the solar panel can not charge the battery because of low voltage. if the symbol is flickering , means the battery is fully charged and has entered float charging state.

P3: Indicate for solar panel. this symbol indicates that the connection of solar panel is detected by controller; if this symbol is not present this means the connection of solar panel can not be detected, or there is no sunshine on the solar panel.

P4: Five bars indicate the level of charge of the battery.

P5: Discharging indication. this symbol indicates that controller is in output state, if this symbol is not seen, there is no load connected or the controller is not delivery power to the load. the flickering of this symbol indicates the damage of internal control devices.

P6: Load indication. this symbol indicates that the controller is in output state, the flickering of this symbol indicates overload or the damage of the load.

P7: A stands for the unit of current; H stands for hour.

P8: V stands for the unit of voltage.

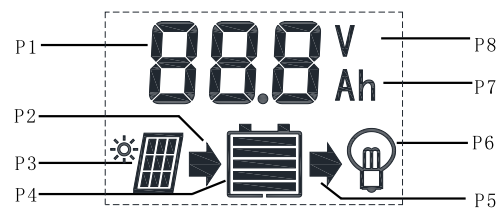

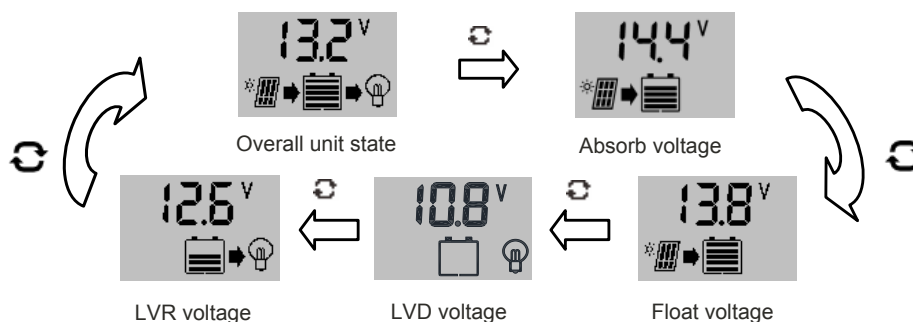

Interface loop switch button, use the button to cycle between pages in each switch cycle sequence shown in (figure 1). Moreover, this button can perform the function of "add" in the parameter setting state.

This button can open or shut off load in the main interface. It can perform the function of "minus" in the parameter setting state.



Viewing and setting the parameters:

The controller will default entry "battery voltage" interface after correct power-on. This is the main interface. Use the button  could in turn visit the following parameters interface. If the parameters in that interface could be set, long press the button  (> 3 seconds, numbers start flashing) to enter the parameter setting interface; calling off the parameter interface after long press the button  again. (The numbers stop flashing)

Overall unit state

This interface shows the overall unit state (pictured at right)
It is the default interface after correct power-on, showing charging and discharging state, 5 bars battery power indication and the voltage of the battery.





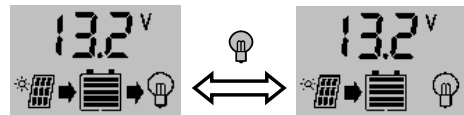

Opening and shutting off the load

You can use the  button on the faceplate to open or shut off the load in the default interface.

Note: There is no such function for this button in other interface.







Viewing and setting the absorb voltage

As pictured at right, the absorb charge voltage is showed. When the battery reaches the absorb voltage, the controller will maintain the voltage values by PWM charging mode to avoid overcharge. Long press the button  (> 3 seconds, numbers start flashing) to finish the setting of absorb voltage values and use the ,  button to adjust the parameter; calling off the parameter interface after long press the button  again. (The numbers stop flashing) The absorb voltage value will be conserved by controller.







Viewing and setting the floating voltage.

As pictured at right, the floating charge voltage is showed. When the battery reaches the floating voltage, the controller will maintain the voltage values by PWM charging mode to avoid overcharge. Long press the button  (> 3 seconds, numbers start flashing) to finish the setting of floating voltage values and use the ,  button to adjust the parameter; calling off the parameter interface after long press the button  again. (The numbers stop flashing) The floating voltage value will be conserved by controller.





Viewing and setting of under-voltage protection

As pictured at right, the value for under-voltage protection is showed. The controller will cut off load circuit when battery voltage is lower than this value, in order to avoid over discharge of the battery. Long press the button  (>3 seconds, numbers start flashing) to enter the setting interface of under-voltage protection and use the ,  button to adjust the parameter; long press the button  again. (The numbers stop flashing) to call off the parameter interface after finish setting. Setting value will be conserved by controller.







Viewing and setting of recovery after under voltage

As pictured at right, the recovery voltage is showed. After the controller performs the function of under-voltage protection, the output of the load will be recovered as soon as the battery voltage recovers to higher than the under-voltage value. Long press the button  (>3 seconds, numbers start flashing) to enter the setting interface of recovery after under voltage; long press the button  again. (The numbers stop flashing) to call off the parameter interface after finish setting. Setting value will be conserved by controller.



Viewing and Setting special parameters

As picture at right, in this page long press the button  (>3seconds) to enter into special parameters page. The parameters of battery type, temperature compensate ratio and load mode can be setup. Then long press the button  to enter into setting mode, use the ,  button to adjust the parameters, long press the  button again (parameter stop flashing) to finish setting. Do not press any button after finish setting, interface will automatically switches to the default page as the picture at right after 10 seconds, setting completed. The special pages are shown as below.



USr: User mode	-4 :	15H: normal mode
SLd: Sealed	-4mV/cell/ C	14H: light control mode
FLd: Flooded		0~13H: light control with time control mode
GEL: Gel		

I Reset to default settings

As pictured at right, in this page long press the button  (>3 seconds) to start up resetting action. When the parameters succeed resetting to default value, the display page switches to next page automatically. The correct process is shown as below.

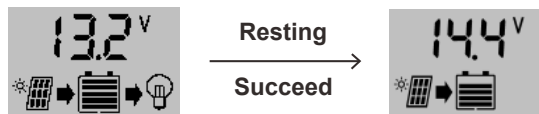

Common Fault and Handling

Under-voltage protection and treatment:

 shows up and flash on the screen means the battery voltage is lower than the under-voltage protection voltage. The controller has enter the under-voltage protection state and the output has been stopped.

Solution: Using solar panel or battery charger to charge battery, when the battery voltage reaches the recovery value, the load will be on power again and enter normal working state.

Overload protection and treatment:

 shows up and flash on the screen, it means the occurrence of over current or short circuit. The controller will stop output and enter overload protection state.

Solution: After solving the problem of output short circuit and reducing the load, press the button.

Input over voltage and handling:

 shows up and flash on the screen means the battery input voltage of the controller is higher than rated input voltage, controller will stop output and enter over voltage protection state.

Solution: 1. please choose battery with appropriate voltage grade to connect with controller; 2. other charger for the battery to be removed.

Specification

Rated Current	10A	HVR	15.5V	
System voltage	12V	No load loss	10.5mA(12V)	
Open circuit voltage of solar panel	< 50V	Charge/discharge voltage drop	< 0.3V/<0.18V	
		USB output	5V/1.5A	
Float voltage	13.8V	Specification of cable	≤ 7 AWG	
LVD	10.8V	Working Temperature	-20℃-50℃	
LVR	12.6V	Storage temperature	-30℃-60℃	
Boost voltage	Sealed 14.4V	Duration	Humidity	10%-90%,NC
	Gel 14.2V		Dimension	3.46 x 6.61 x 1.10 in
	Flooded 14.6V	2Hours	Weight	0.49 Lb
HVD	16.0V			

Manufacturer retains the right to modify this product at any time without notice.

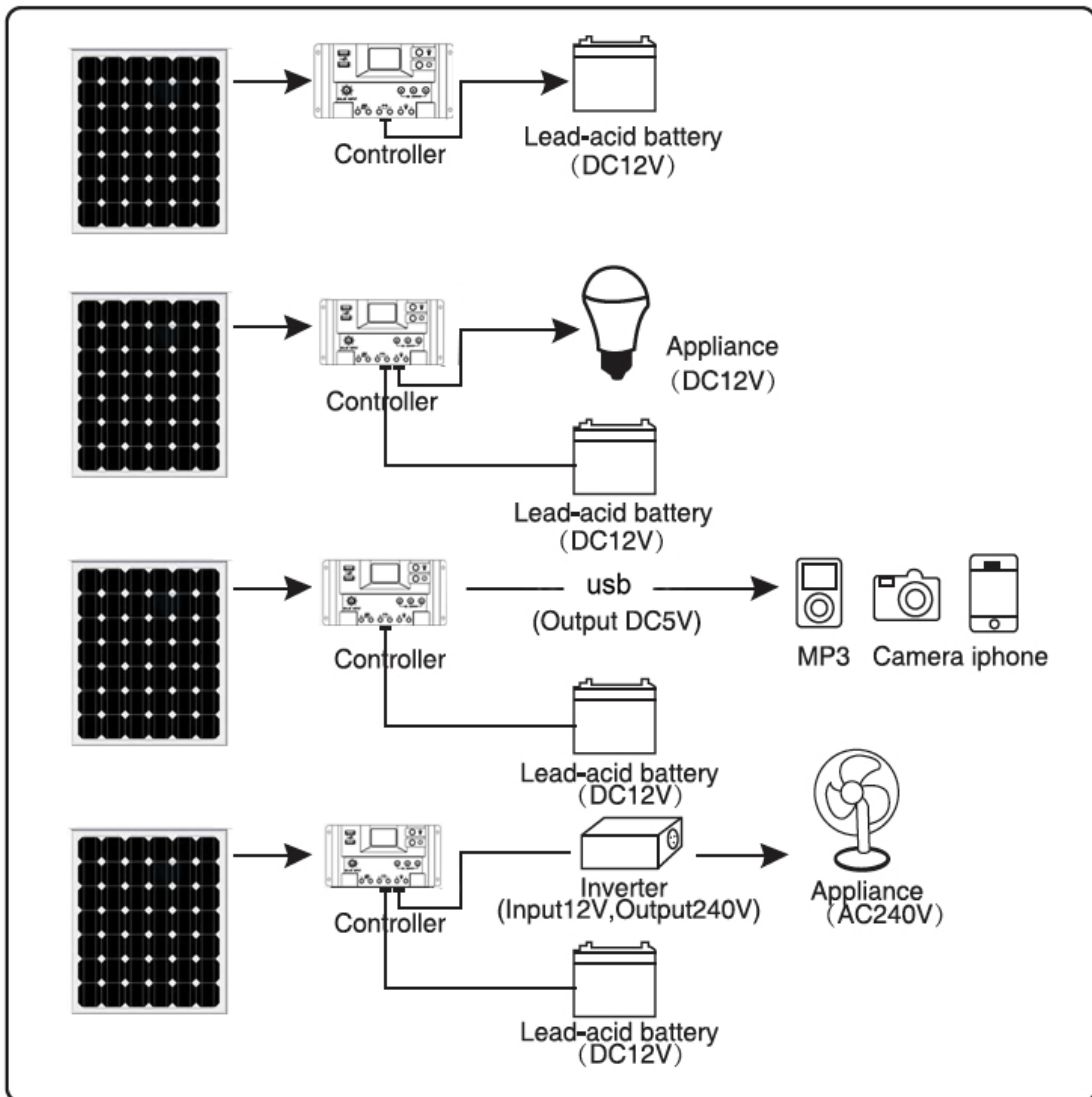

Limited Warranty

Nature Power warrants our products to the original purchaser that this product is free from defects in materials and workmanship for the period of 1 year from date of purchase, 2 year warranted to generate up to 80% of rated power from date of purchase. In the case of product defect, contact Nature Power customer service to receive troubleshooting. If defective part or unit should be returned, a Return Authorization Number must be issued by Nature Power and the defective part or unit should be returned to the authorized location at the purchasers' expense. A dated proof of purchase is required to receive warranty service. Once received at authorized location and defect proves to be the result of defective material and workmanship, the defective part or unit will be replaced at warrantors' option and returned to the original purchaser at warrantors' expense. No refunds will be granted by the warrantor, in the event of buyer's remorse please contact your point of purchase within and in adherence to their return policy. Refunds are granted at the retailers' discretions.



Please contact Nature Power Products to acquire more information:

1-800-588-0590

info@naturepowerproducts.com

www.naturepowerproducts.com

Made in Vietnam