

SEAVIEW

ELEVATE YOUR ELECTRONICS

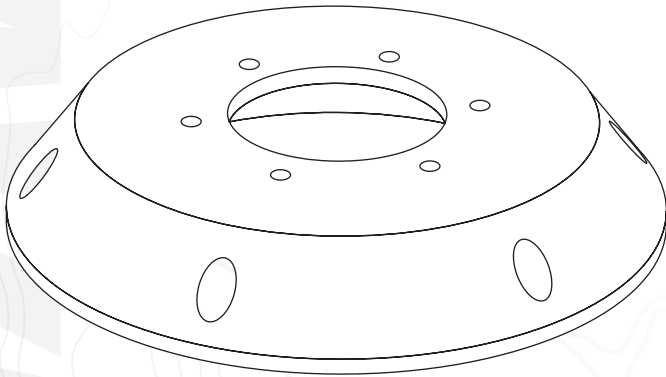

INSTALLATION INSTRUCTIONS

For Seaview Top Down Risers:
FTDR-2, FTDR-3, FTDR-4, FTDR500

Refer to website for most up to
date instructions and videos.

WWW.SEAVIEWGLOBAL.COM

PARTS INCLUDED

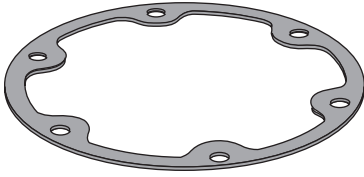

X1

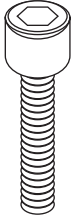

M6 x 16mm

X6

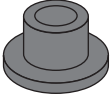

X6 Only for FTDR500

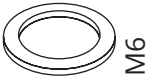

M6

X6

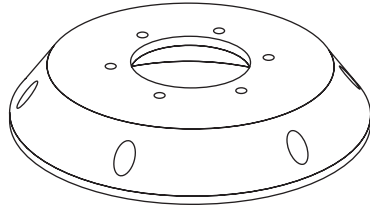

X1

TOOLS NEEDED

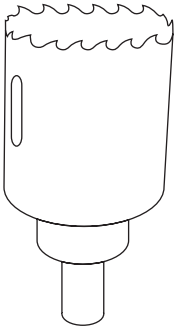

Sudbury Elastomeric Marine Sealant is recommended. To purchase call 800-655-7922 or visit www.seaviewglobal.com

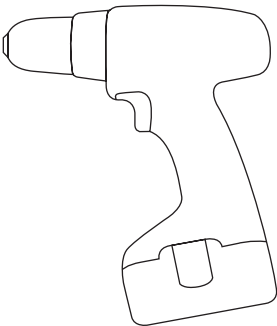

1

Mark all the holes to drill, and then drill.

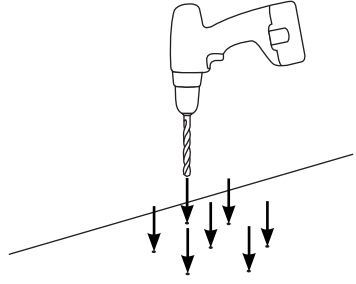
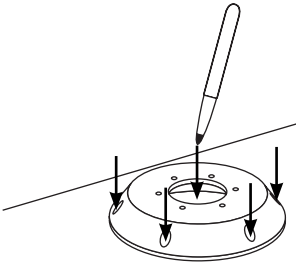

2

Use a hole saw to cut a hole offr the center cable.

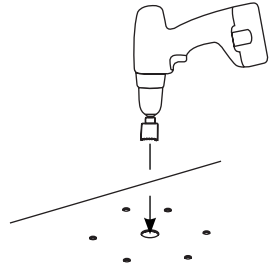

3

Bolt the camera to the Top Down Riser using the six bolts and washers.

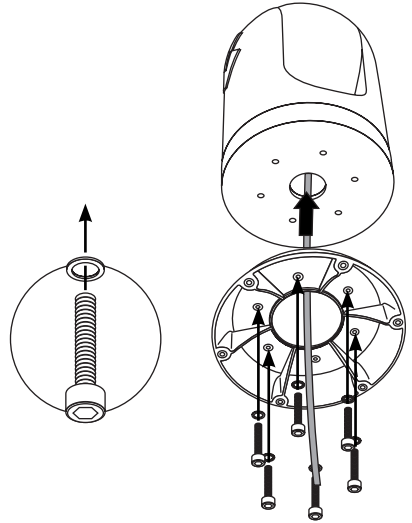

4 Apply marine adhesive sealant to the rubber gasket and underside of the Top Down Riser.

Secure the Top Down Riser to the surface with your hardware. Be sure to not exceed 20 inch pounds. Use the six provided black nylon shoulder washers for the FTDR500.

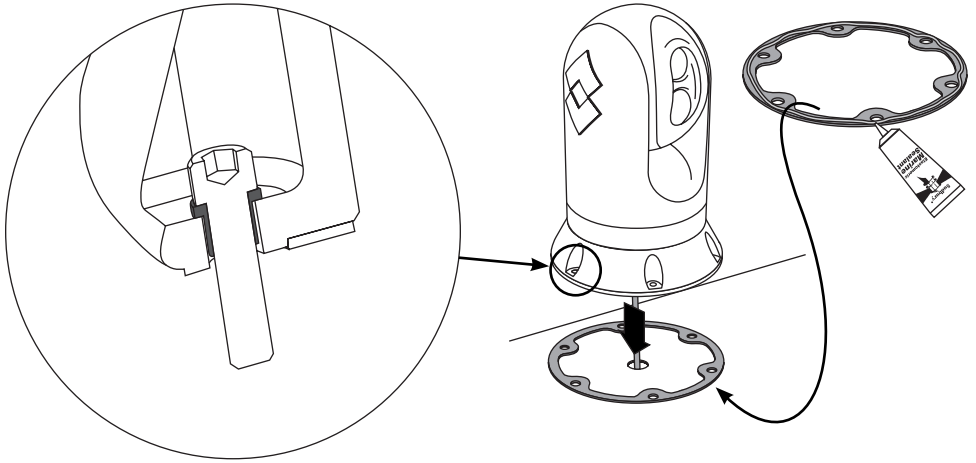

OPTIONAL

You may consider using a Seaview Cable Gland for routing the cables through the mounting surface.

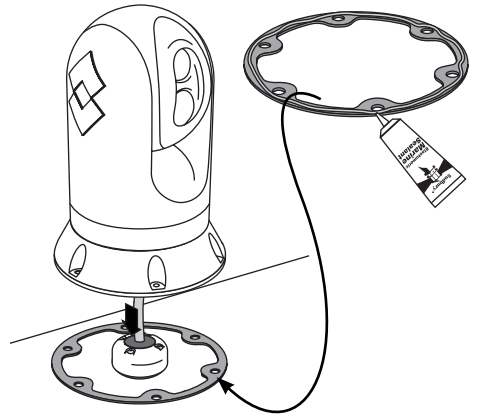

OPTIONAL ACCESSORIES

Call 800-655-7922 or visit www.seaviewglobal.com for available accessories.

CABLE GLANDS

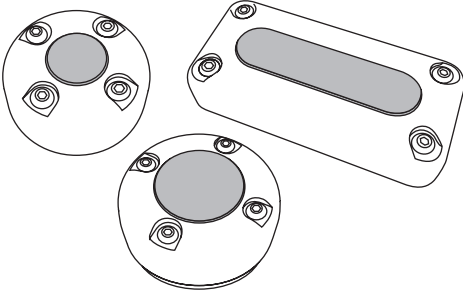

Seaview Cable Glands provide waterproof cable routing.

The background of the entire page is a light gray topographic map with white contour lines. The lines are irregular and wavy, representing elevation changes across a landscape. The map is centered and fills the entire frame.

SEAVIEW//
ELEVATE YOUR ELECTRONICS

SEAVIEW//

Tel: 800-655-7922
www.seaviewglobal.com

EUROPEAN OFFICE

Tel: +33 4 94 53 27 70
www.seaviewprogress.com

3-010519